

Where great curb appeal meets the strength, security and durability of coated steel.

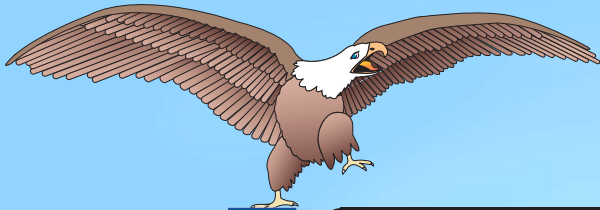

ORNAMENTAL STEEL FENCING
INTREPID[®]

RESIDENTIAL • COMMERCIAL • INDUSTRIAL



NATIONAL FENCE
NFS
SINCE 1985
SYSTEMS, INC.

www.nationalfencesystems.com

ABOUT



National Fence Systems, Inc. is a family owned fence company that specializes in the manufacturing, distribution, and installation of quality fence products. We have been in the same location for almost 30 years and have successfully serviced thousands of customers.

We manufacture:

- Intrepid Ornamental Steel Fence
- Gemstone Ornamental Aluminum Fence
- Classic Vinyl Fence
- Traditional Wood Fence
- Arch Backstops

and with our unique capabilities can custom build practically anything to fit your project needs.

We also carry and install:

- chain link fence
- privacy slates
- guiderail, etc...

Our large inventory of readily available products allows you to get what you need when you need it!

We are licensed, bonded, and insured to do any type



of fence work. Our professional, courteous and service oriented staff is looking forward to assisting you in choosing which product best fits your needs.

NFS Showroom & Design Center

Our showroom/design center is open 5 days a week and Saturdays seasonally. If you can't stop in, one of our sales consultants will gladly make an appointment to meet you at your property. Whether you need a simple repair of a complete fence system, no job is too large or small.

We look forward to providing you with a positive experience and a fence that exceeds your expectations!



National Fence Systems, Inc.

1033 Route 1 South, Avenel, New Jersey 07001
1.877.484.6953 • 732.636.5600 • FAX: 732.636.5605
info@nationalfencesystems.com
www.nationalfencesystems.com



ABOUT

ORNAMENTAL STEEL FENCING INTREPID®

Here at **National Fence Systems**, we provide and install INTREPID Ornamental Steel Fences.

These fences are manufactured with heavy-duty bonded framework for added sturdiness and strength. Our top quality steel has been treated with a high-performance polyester coating to resist corrosion and weather damage. Its durability ensures that you will have minimal maintenance and a beautiful fence that lasts even under the harshest weathering environments.

On top of having low upkeep, ornamental steel fencing adds an elegant structural element to your property. It adds a sophisticated look and a high level of security to your property. Plus, it blends in with all types

of settings and is available in a variety of styles.

Standard sections come in 6' and 8' lengths. We also provide a wide array of standard colors for you to choose from. You can easily order your steel fence in customized heights and styles, such as, decorative finials, post caps and scrolls to fit your needs.

It's our company's goal to make sure that you find the perfect fence to complete your property. We provide full manufacturing and installation services for residential, industrial, and commercial applications on the East Coast to ensure that you're fully satisfied with your fencing.

Please call us for a free quotes on your ornamental steel fence today.

National Fence Systems, Inc. ♦ 1.877.484.6953 ♦ info@nationalfencesystems.com

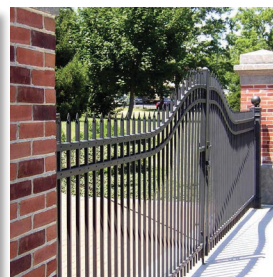

INTREPID PRODUCT LINE INDEX

Fully Assembled Products	4	High Security Fencing	8
Maintenance Free • Kolor King Coatings	5	Swing Gates	8-9
Specifications	6	Slide Gates	10
INTREPID Fence Line	7	Accessories	11

FULLY ASSEMBLED

National Fence Systems, Inc. is the ONLY major manufacturer that ships all fence sections, gates and posts fully assembled. Rail brackets are attached to the post, and then polyester coated after fabrication.

No assembly is required. Our sections are fastened with aluminum industrial drive rivets – allowing sections to rack up to 20% to allow for uneven ground.

All rails fastened to brackets with stainless steel security fasteners

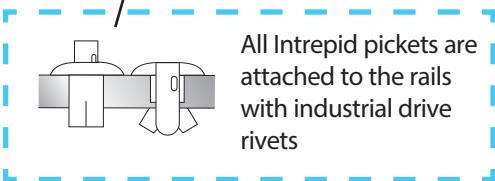
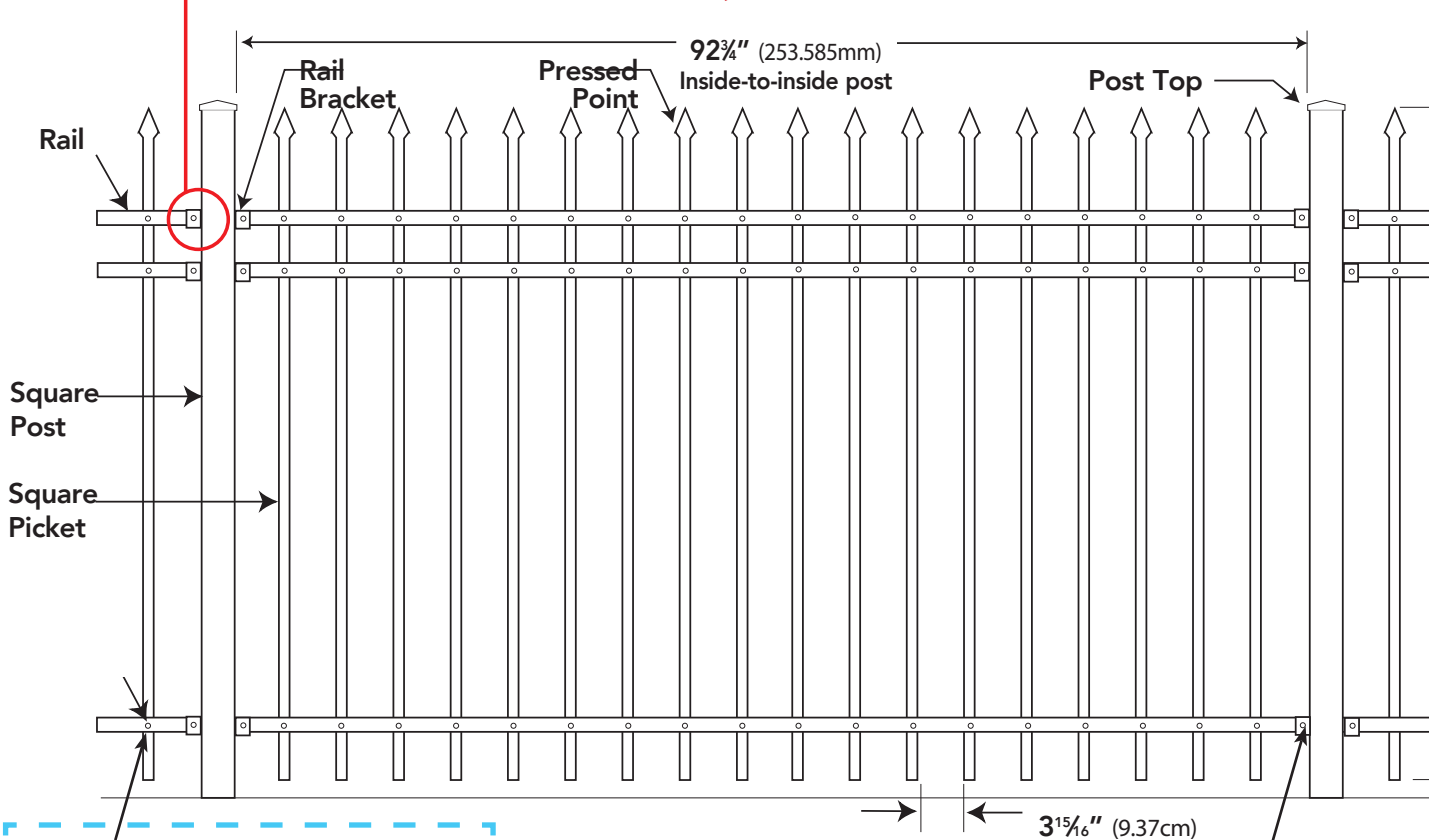

◆ All Fence Sections, Gates and Posts Shipped Fully Assembled!

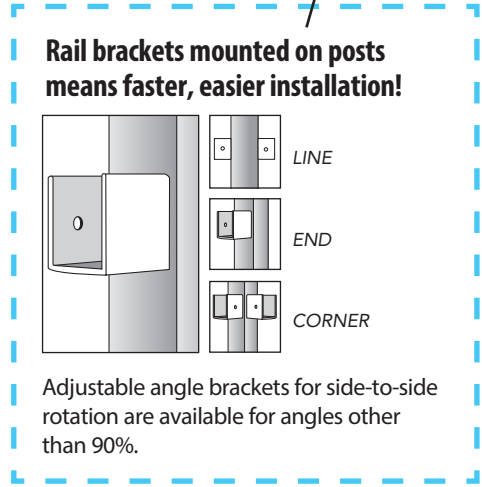

Intrepid Fences are shipped with all rail brackets pre-mounted on posts.

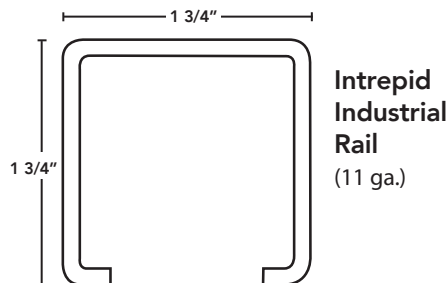
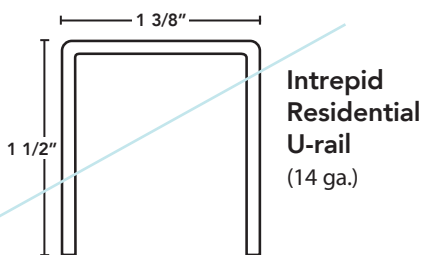

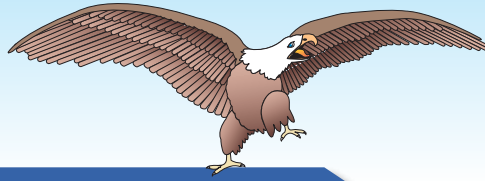

MAINTENANCE-FREE

Exclusive high-performance coating system makes our ornamental steel fences virtually maintenance-free.

All **Intrepid Ornamental Steel Fencing** systems are coated with our Kolor King® high performance polyester powder coating, designed for the harshest outdoor weathering environments. Formulated for the toughest marine and architectural applications, the Kolor King Super Durable Polyester Coating delivers up to double the exterior durability for gloss and color retention.

In addition, the Super Durable Polyester Coating has demonstrated a 30% improvement in corrosion resistance in acid rain environments – compared with standard TGIC polyester powder coatings.

High-Performance

This high performance coating has been formulated to meet the AAMA 605 High Performance Specification and to meet or exceed AAMA 604 and the European Qualicoat Standard.

These coatings are very smooth, as expected in an architectural application. They come in a variety of colors, gloss, metallics, and clear.

KOLOR KING® Super Durable Polyester Powder Coatings

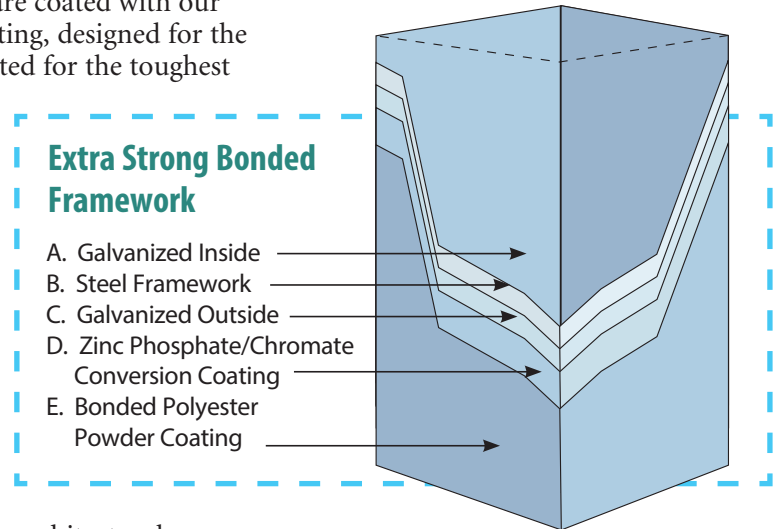

Kolor King® Colors

In addition to the standard colors below, Intrepid Ornamental Steel fences are also available in over 40 additional “standard” colors.

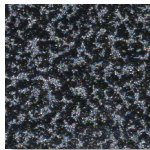

Hammerstone
Black

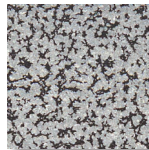

Hammerstone
Silver



Hammerstone
Green



Black



White



Green



Bronze

Kolor King® 10-Year Limited Warranty

Kolor King® warrants to the original purchaser of the fencing that the electrostatically applied powder coated finish will not crack, chip, or peel for a period of 10 years from date of installation or purchase. This warranty does not extend to damage caused by use other than the normal use for which the fence is intended, negligence, alteration, accident, improper installation, abuse, misuse, vandalism or acts of god. Excluded from the warranty are points of welding inherent in the style of fence or otherwise requested by the purchaser.

All claims for a breach of this warranty shall be submitted to Kolor King in writing describing the nature of the breach together with a photograph of the defective portion of the fence and a copy of the original installation agreement or invoice. Kolor King reserves the right to determine if the claim is valid. If the claim is valid, Kolor King shall, at its discretion, either repair or replace the defective portion of the fence. However, all removal, shipping, and reinstallation cost are the sole responsibility of the purchaser.

The above set forth Kolor King complete warranty and the remedies against Kolor King with respect to the fence. No ADDITIONAL WARRANTIES ARE GIVEN, EXPRESS, STATUTORY OR IMPLIED, ANY IMPLIED WARRANTY OF MERCHANTABILITY, OR FITNESS FOR A PARTICULAR PURPOSE IS HEREBY EXPRESSLY DISCLAIMED. KOLOR KING shall not in any event be responsible for consequential, personal injury, or incidental damages. No person or entity is authorized to change, modify or supplement this warranty, and any such attempt and any other written or implied agreement shall not be valid as against Kolor King.



SPECIFICATIONS

Material: Pickets, Rails, Posts

■ **VERTICAL STEEL PICKETS** are made of hot rolled structural steel with a minimum tensile strength of 50,000 psi. Pickets are manufactured as per ASTM A513 and hot dipped galvanized as per ASTM A525-G90. Space between pickets shall be 3 1/16" (10.001cm) face to face.

■ **HORIZONTAL STEEL RAILS** are made of roll-formed structural steel with a minimum tensile strength of 50,000 psi. Rails are manufactured as per ASTM A513 and hot dipped galvanized as per ASTM A523-G90.

■ **STEEL POSTS** are made of hot rolled structural steel with a minimum tensile strength of 50,000 psi. Posts are manufactured as per ASTM A513 and hot dipped galvanized as per ASTM A525-G90.

Accessories

■ All Decorative Finials, Rings, Lettering, Post Caps, Ball Caps and Scrolls are made die cast aluminum, per ASTM A319.

Fabrication

■ **RAILS** are punched to allow pickets to pass through the rail. The number of rails vary with style, height and strength as determined by National Fence Systems, Inc.

■ **PICKETS**, as a standard, are riveted or may be, as an option, welded to rails. Pickets are riveted to rails using a 1/4" industrial aluminum drive rivet.

■ **POSTS** are manufactured with post rail brackets mounted for easy installation. The post rail bracket is fastened to each end, line, and/or corner post and is polyester coated after fabrication.

■ **GATES** are fabricated using the same components as for the complete fence system. All Gates are welded first and then polyester powder coated after fabrication. Type of gates available: single, double drive, and

cantilever aluminum track. Hinges and latches are fitted according to gate size and mode of usage. Various Gate operators can be installed on all gates.

■ All fence sections, gates and posts are shipped fully assembled; posts having the rail brackets attached first and then polyester coated after fabrication. No assembly is required. Unassembled sections and blank posts are available upon request.

Finish

All fence components have a galvanized undercoat, inside and outside all members, to insure maximum corrosion resistance.

The complete fence system is coated using our environmentally approved Kolor King™ Super Durable

High Performance Powder Coating process (see page 3).

Installation

Gate posts should be posted according to gate openings specified. Fence Posts are to be set at a spacing of either 71" for 6' o.c. nominal or 9 5/12" for 8' o.c. nominal with 2 1/2" square posts. Fence Panels should be attached into the mechanically fastened post rail bracket on each post and fastened with a stainless security fastener. Adjustable angle brackets available for installation on uneven terrain.

Manufacturer

National Fence Systems, Inc.
1033 Route 1 South
Avenel, New Jersey 07001
1-877-484-6953

Intrepid RESIDENTIAL Ornamental Steel Fencing

ITEM	Size (sq.)	Wall Thickness	Wgt./ft. (lbs)	Tensile Strength (psi)
Picket	3/4" (1.095cm)	18 ga (.047)	.467	50,000
Rail: U-channel	1 3/8"x1 1/2" (3.49x3.81cm)	14 ga (.083)	1.134	50,000
POST OPTIONS				
Post: Option 1	2" (5.08cm)	14 ga (.083)	2.164	50,000
Post: Option 2	2 1/2" (6.35cm)	14 ga (.083)	2.728	50,000

Intrepid INDUSTRIAL Ornamental Steel Fencing

ITEM	Size (sq.)	Wall Thickness	Wgt./ft. (lbs)	Tensile Strength (psi)
Picket: Option 1	1" (2.54cm)	18 ga (.047)	.634	50,000
Picket: Option 2	1" (2.54cm)	16 ga (.065)	.827	50,000
Picket: Option 3	1" (2.54cm)	14 ga (.083)	1.035	50,000
Rail: U-channel	1 3/4"x1 3/4" (4.45x4.45cm)	11 ga (.120)	2.20	50,000
POST OPTIONS				
Post: Option 1	2 1/2" (6.35cm)	14 ga (.083)	2.728	50,000
Post: Option 2	3" (7.62cm)	11 ga (.120)	4.288	50,000
Post: Option 3	4" (10.16cm)	11ga(.120)	6.332	50,000

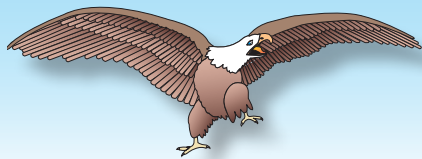

THE INTREPID LINE

Residential, Commercial and Industrial Fencing

Strength, durability, beauty and affordability. These are the qualities that have attracted design professionals to our Ornamental Steel Fencing for more than 20 years.

Our steel fences provide an elegant and affordable alternative to wrought iron. Installation is quick and easy because we ship our fence sections fully assembled, with rail brackets mounted to posts. Pickets are attached to the rails with industrial drive rivets, which adds strength and stability, while allowing racking to accommodate uneven

ground surface. The INTREPID line features the flexibility of 10 popular two, three, and four-rail design styles to choose from – all in a variety of standard heights, and colors. Standard sections come in 6’ and 8’ lengths. Most of our standard styles are constructed to meet BOCA codes. We also provide custom options such as convexing, concaving, decorative finials, post caps and scrolls.

Custom heights and lengths, as well as all-welded sections are also available.

HAWK

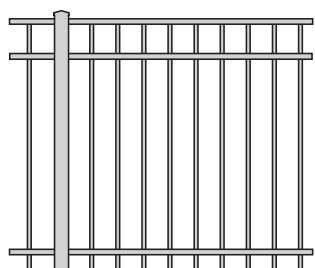

HAWK 2

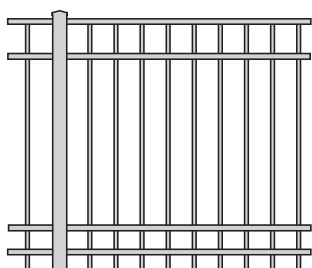

OSPREY

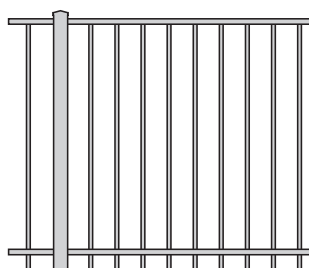

RAPTOR

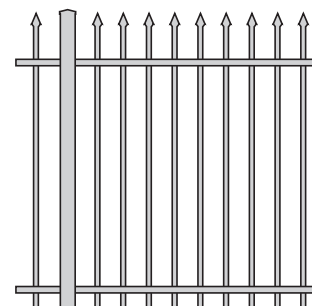

EAGLE

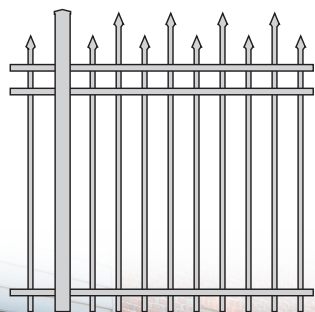

EAGLE 2

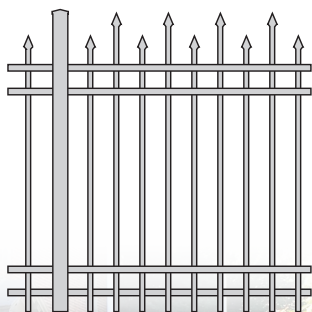

KESTREL

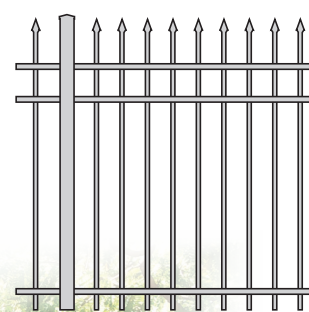

KESTREL 2

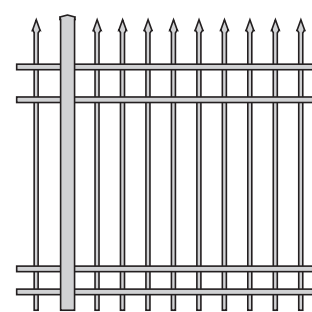

Designed for Ease of Installation!

National Fence Systems, Inc. has engineered the Intrepid Line for efficient, trouble-free installation.

All of our sections are shipped FULLY ASSEMBLED; and all brackets are mounted to POSTS as a standard.



SWING GATES

All INTREPID swing gates are constructed to the highest standard in the industry, with 2" x 2" (5.08 x 5.08cm), 14-gauge steel uprights standard on residential and commercial gate frames.

All gate frames and pickets are shipped fully assembled, and are welded at all joints for added strength.

See page 11 for decorative options.

HIGH SECURITY FENCING

The Condor

The Condor is the Maximum Security fence in the INTREPID line. Standard Condor fences are manufactured with angled pickets and pointed tops (Condor A). Pickets are also available with 1/4 circle (Condor B) and 1/2 circle tops (Condor C).

CONDOR

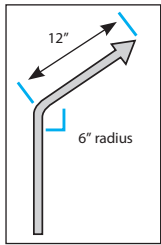
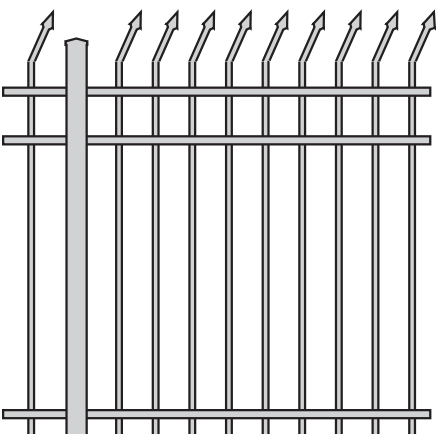

Condor A
(standard)

CONDOR 2

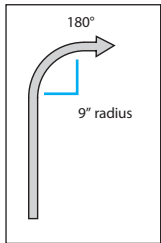
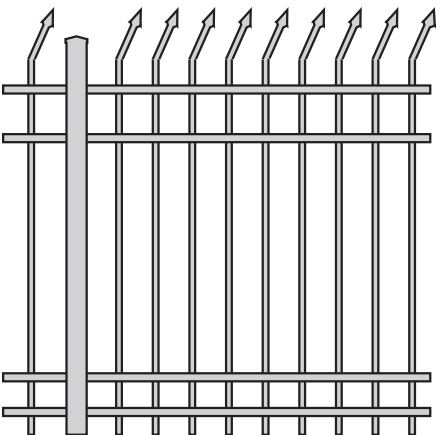

Condor B
(optional)

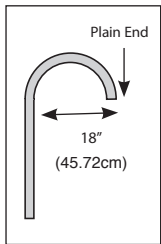

Condor C
(optional)

SINGLE SWING GATES

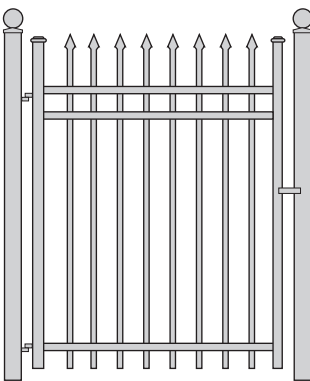

product name here



product name here

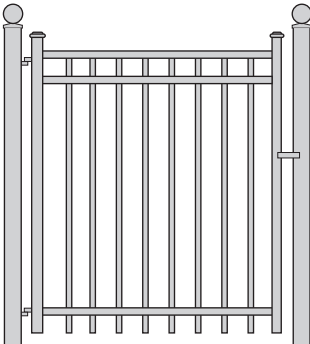

product name here



product name here

Choose any style!

We have pictured above and right the most popular styles of gates. In addition to these styles, National Fence Systems, Inc. manufactures gates to match every fence style. Custom gate styles and accessories are also available.

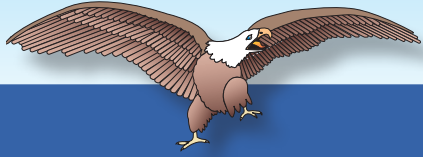

DOUBLE SWING GATES: up to 32 ft. opening

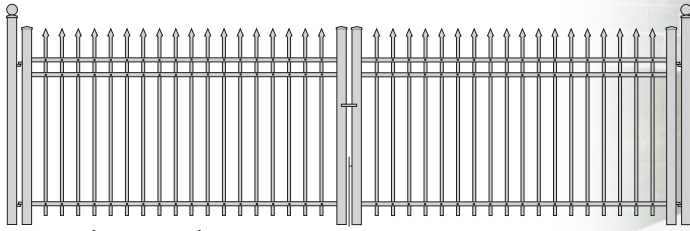

product name here

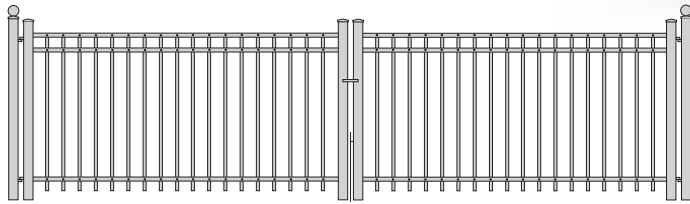

product name here

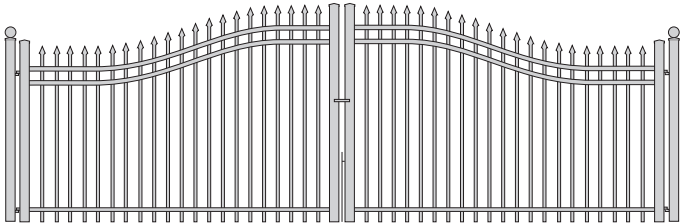

product name here

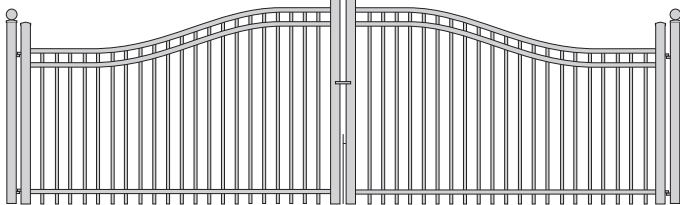

product name here



SWING GATES HARDWARE

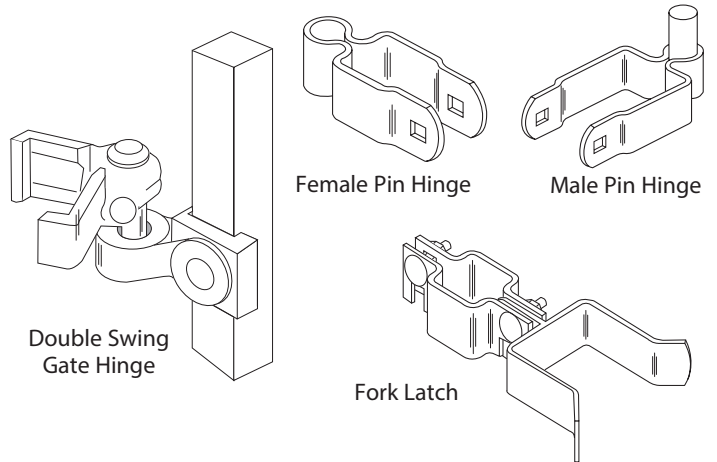

Double Swing Gate Hinge

Female Pin Hinge

Male Pin Hinge

Fork Latch

Optional Gate Hardware

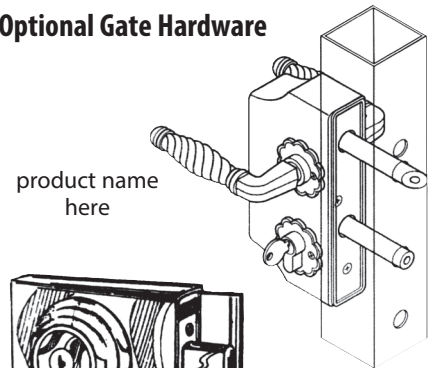

product name here

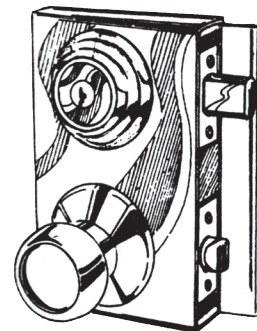

product name here



SLIDE GATES



EasyGlide Cantilever Gates

Box gates also available for up to 40' openings.

INTREPID utilizes the exclusive EasyGlide™ Aluminum Track system for all of our cantilever ornamental steel gates. This system, featuring a fully enclosed, high performance aluminum track provides smooth gate operation with limited lateral movement.

INTREPID Ornamental Steel Fence Systems are backed by a 10 year limited warranty. Let our knowledgeable and helpful staff of experts help you choose the perfect style for your home or business.

Superior Strength

Intrepid EasyGlide gate frames feature a 2" x 4" frame guide, which exceeds the industry standard of 2" x 2". This helps maintain proper alignment, and provides our gates with superior strength and dimensional stability.

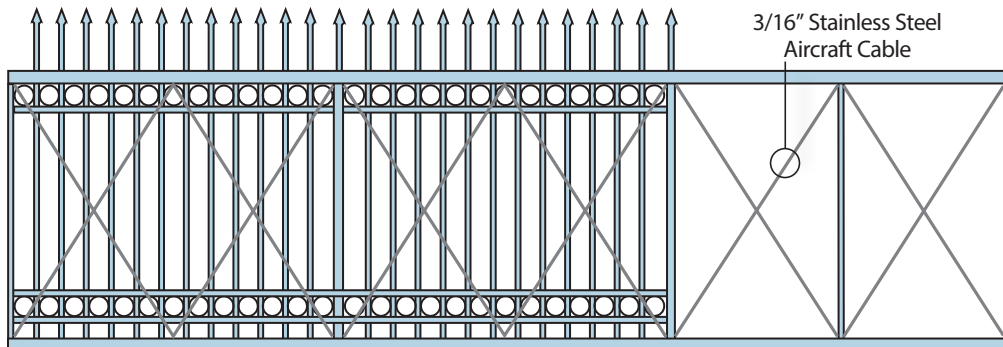

EasyGlide GATE TRACKS

SINGLE: For gates from 3 ft. up to 30ft.

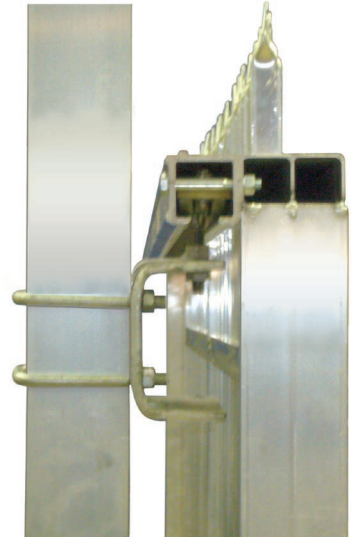

Aluminum Track Gate Systems

- Fully enclosed high performance aluminum track (6061T6)
- To provide for smooth operation gate rides on tracks utilizing a sealed ball bearing system and horizontal wheels in the truck assembly
- Lower guide system and horizontal wheels in track assembly effectively limit lateral movement
- Single gate openings up to 30' and double track gates available up to 36'; Technical and design assistance can be provided upon request.



Heavy Duty Truck Assembly

Our truck assembly is designed to swivel up or down to accommodate gate frame movement.

Standard galvanized steel Slide Gate Latch.

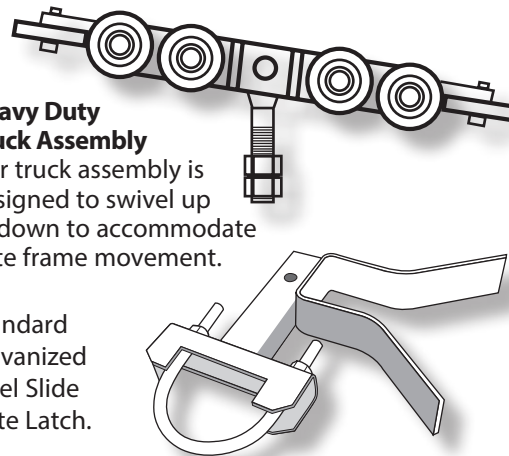

DUAL: For gates up to 36ft.

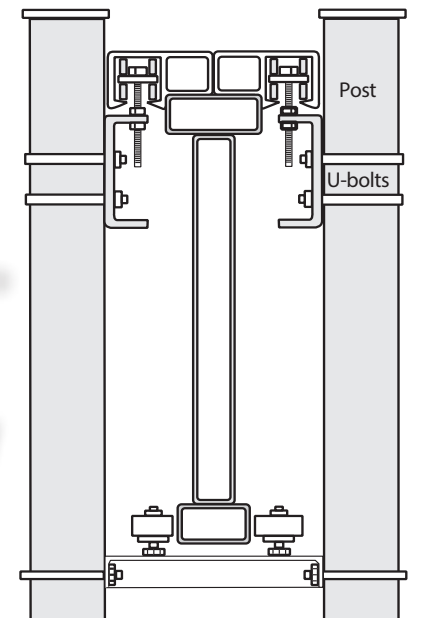

◆ All Slide Gates Shipped Fully Assembled!



Intrepid Fence & Gate Accessories

Simple accessories options, like rings and lettering, add elegance and curb appeal to the Intrepid line of Ornamental Steel fencing and/or gate choices.

PICKET OPTIONS



POST OPTIONS

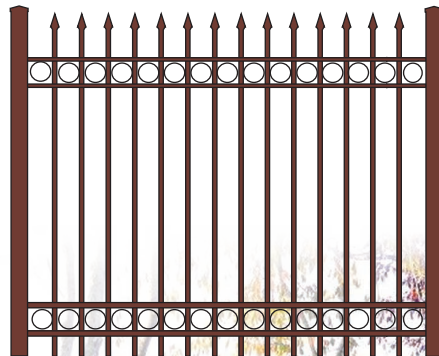
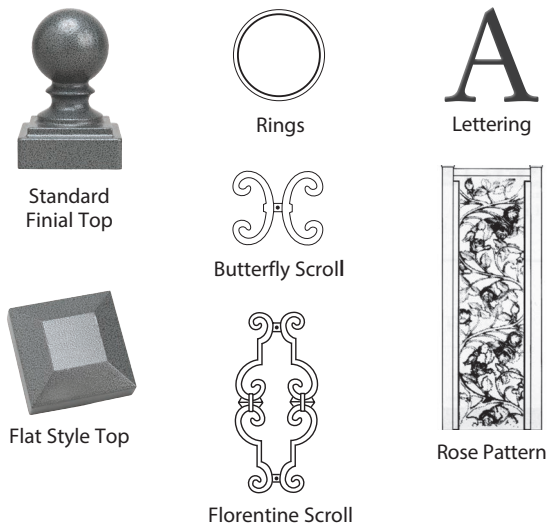

Double Rings

Double rows of rings are a popular accessory item to dress up a simple straight-picket fence.



◆ All Accessories Are Shipped Already Installed!

MORE FROM...

National Fence Systems, Inc.

New Jersey's Superior Manufacturer & Installer of Fence Systems

National Fence Systems is New Jersey's supreme full service manufacturer and installer of fencing systems for Residential, Commercial, and Industrial applications on

the East Coast. National Fence Systems has been providing the fence industry with an assortment of products and services for over 30 years.



GEMSTONE ALUMINUM FENCE

Lorem ipsum dolor sit amet, consectetur adipiscing elit, sed do eiusmod tempor incididunt ut labore et dolore magna aliqua. Ut enim ad minim veniam, quis nostrud exercitation ullamco laboris nisi ut aliquip ex ea commodo consequat. Duis aute irure dolor in reprehenderit in voluptate velit esse cillum dolore eu fugiat nulla pariatur. Excepteur sint occaecat cupidatat non proident, sunt in culpa qui officia deserunt mollit anim id est laborum.



TRADITIONS WOOD FENCE

Lorem ipsum dolor sit amet, consectetur adipiscing elit, sed do eiusmod tempor incididunt ut labore et dolore magna aliqua. Ut enim ad minim veniam, quis nostrud exercitation ullamco laboris nisi ut aliquip ex ea commodo consequat. Duis aute irure dolor in reprehenderit in voluptate velit esse cillum dolore eu fugiat nulla pariatur. Excepteur sint occaecat cupidatat non proident, sunt in culpa qui officia deserunt mollit anim id est laborum.



CLASSIC VINYL FENCE

Lorem ipsum dolor sit amet, consectetur adipiscing elit, sed do eiusmod tempor incididunt ut labore et dolore magna aliqua. Ut enim ad minim veniam, quis nostrud exercitation ullamco laboris nisi ut aliquip ex ea commodo consequat. Duis aute irure dolor in reprehenderit in voluptate velit esse cillum dolore eu fugiat nulla pariatur. Excepteur sint occaecat cupidatat non proident, sunt in culpa qui officia deserunt mollit anim id est laborum.



ARCH BACKSTOP

Lorem ipsum dolor sit amet, consectetur adipiscing elit, sed do eiusmod tempor incididunt ut labore et dolore magna aliqua. Ut enim ad minim veniam, quis nostrud exercitation ullamco laboris nisi ut aliquip ex ea commodo consequat. Duis aute irure dolor in reprehenderit in voluptate velit esse cillum dolore eu fugiat nulla pariatur. Excepteur sint occaecat cupidatat non proident, sunt in culpa qui officia deserunt mollit anim id est laborum.

1.877.484.6953

Manufactured By:



www.nationalfencesystems.com

Distributed By: